

ON DISPLAY

THE PRECISION DIGITAL MAGAZINE

**Advanced
Data
Collection at
Oil Fields**

**WHEN EVERY INCH
COUNTS**
Rely on Feet & Inches
Displays

**BACK TO
BASICS:**

{PART 2}

The
Fundamentals of
Loop-Powered
Devices

**HAZARDOUS AREA
CLASSIFICATIONS:**
What You Need to Know



Not a subscriber?
 Subscribe to **ON DISPLAY**
subscribe.predig.com



Reader's Brief

This issue is entirely dedicated to hazardous areas. Editorial includes "Fundamentals of Loop-Powered Devices," Part 2 of the Back to Basics Series. Discover loop-powered instruments and their relationship to hazardous areas. Also on this issue is the "Hazardous Area Classifications: What You Need to Know" article. This covers all the essential information about classifying these environments as well as best practices to help you make more informed decisions. You may also watch the recorded webinars for these two articles at predig.com/webinars.

Precision Digital has launched the 2015 Catalog and Price List this May. To request a copy, see back cover for details.

- Precision Digital

Table of Contents

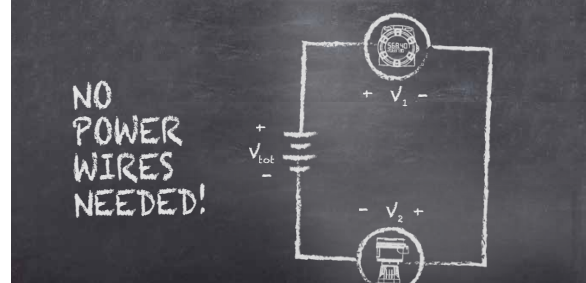

Back to Basics: {Part 2} The Fundamentals of Loop-Powered Devices

4

When Every Inch Counts Rely on Feet & Inches Displays

8

Letter from Sales: Advanced Data Collection at Oil Fields

9



Hazardous Area Classifications: What You Need to Know

11

contact us



U.S. & Canada
 1-800-343-1001



Tech Support
support@predig.com

International
 1-508-655-7300

Sales
sales@predig.com



Corporate Office
 89 October Hill Road • Holliston, MA 01746 USA

Instruction At Your Fingertips



Learn By Doing with the Interactive Trident Virtual Meter

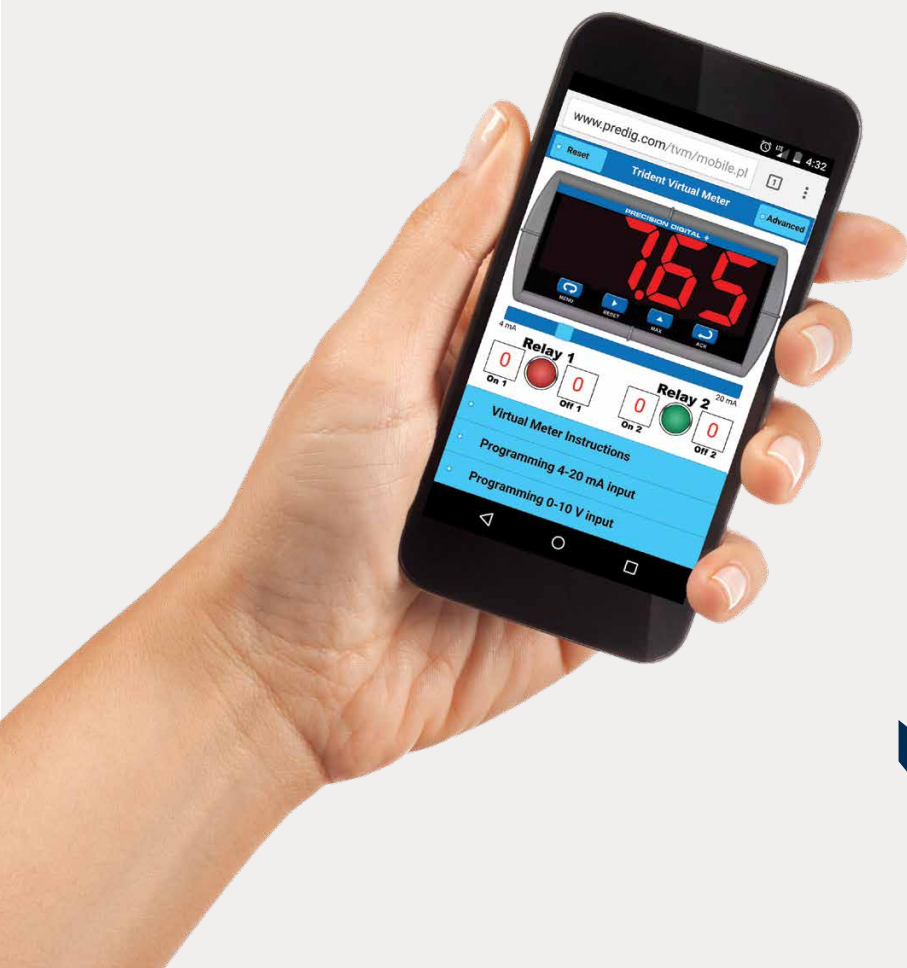

Learn to program the Trident X2 Process & Temperature meter using the new Trident Virtual Meter for smartphones and tablets. Check it out on your mobile device today!

tvm.predig.com



 **TRIDENT**
Virtual Meter

{PART 2}

BACK TO BASICS:

The Fundamentals of Loop-Powered Devices

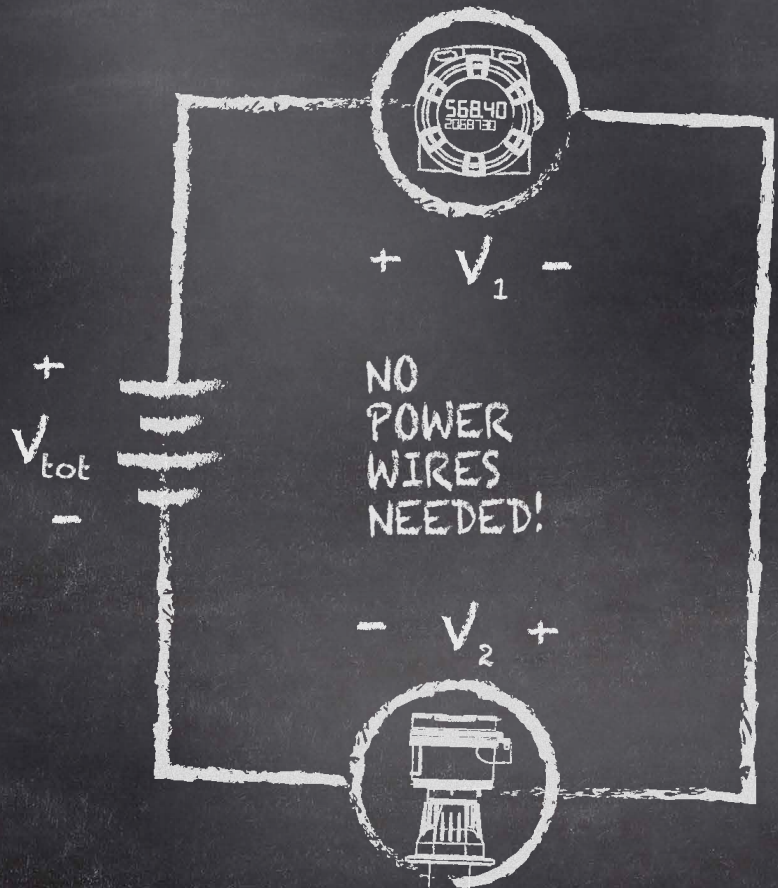

What Are Loop-Powered Devices?

Recalling from the previous part of this series, all 4-20 mA current loops require a power supply in order to operate. A lot of loop setups will utilize an external power supply in order to power the devices which are attached to the current loop. It is possible, however, to power all the instruments on the loop with the power supplied for the loop itself. These devices are referred to as *loop-powered*. This

particular setup can be used in situations where it is not practical to supply separate power to all of the devices or in hazardous areas where a low power solution is required. Working in an industry that requires process control, it is imperative to understand whether implementing a loop-powered solution is appropriate or not for your setup.

A fundamental principle of electricity is that current is the same at all points in a closed current loop. This is why the 4-20 mA current loop is the ideal analog standard for transmitting information over long

“The current will always remain consistent at all devices in the loop.”

distances, and through multiple meters, transmitters, data loggers, and other 4-20 mA loop devices.

The current will always remain consistent at all devices in the loop. As long as there is sufficient voltage, a 4 mA signal generated at the transmitter will still be a 4 mA signal when it reaches the receiver.

Defining Characteristics of Loop-Powered Devices

Approved for Hazardous Areas

Often approved as Intrinsically Safe (I.S.) or Non-incendive (N.I.) for use in hazardous areas.

Open Collector or Passive Outputs

These are often the only two types of discrete outputs available.

LCD Displays

LCD displays provide clear indoor and outdoor indication and are popular in loop-powered devices due to their low electrical power consumption.

Limited Serial Communications

Options are extremely limited, or quite slow and inefficient.

2-Wire Connections

Wiring is easy as it only requires 2 wires between instruments.

Lower Costs

A lower cost solution by comparison.

Explosion-Proof

Available for some devices. It is a more convenient installation, as no power source or wiring is necessary.

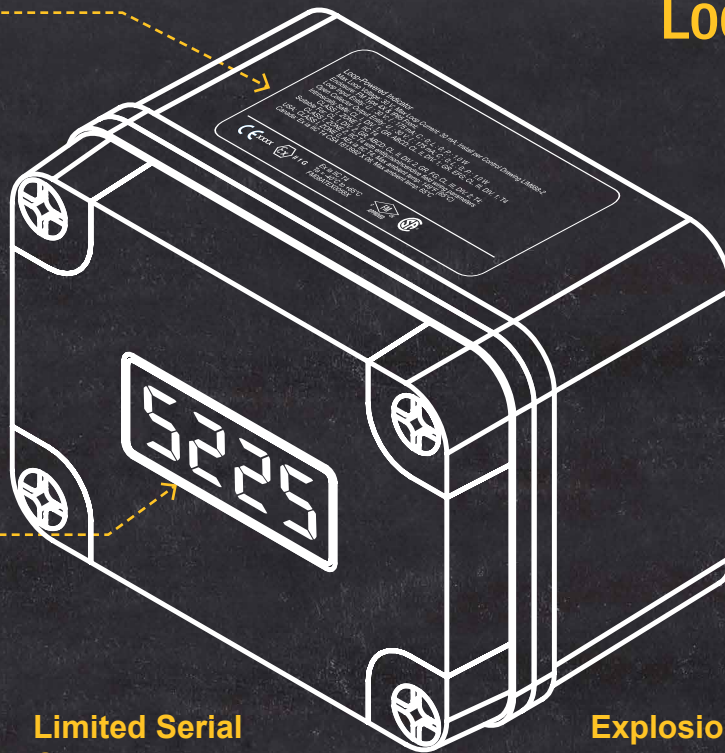

This fundamental factor allows as many devices as the power supply can support to be powered by the current loop without affecting the process signal. A loop-powered device is simply a process control device, such as a digital display, that takes advantage of this principle to power itself off of the 4-20 mA loop without affecting the current levels in that loop. Loop-powered instruments by their nature need to consume very little power in order to be able to operate with the finite power supplied to the loop. Consequently this fact defines the features found in loop-powered devices and their applications.

Defining Characteristics

Loop-powered devices come with two input connections: a positive (+) and a negative (-). The current signal enters through the positive (+) terminal and leaves via the negative (-) terminal. Therefore the term 'loop-powered' is synonymous with the term '2 wire' (meaning that only 2 connections/wires are involved in any of the connections between the transmitter, the power source and the output device).

In addition to being easy to wire and requiring very little power, there are a few other defining characteristics of loop-powered devices. They typically do not feature LED displays nor mechanical relays. Process outputs and serial communications capabilities are quite limited. Loop-powered devices, however, are normally less expensive, easier to install and will often feature hazardous area approvals such as Intrinsically Safe (I.S.) and Non-incendive (N.I.). Explosion proof loop-powered devices are also common as they significantly simplify installation.

Advantages

There are a few advantages to utilizing the power supplied for the current loop to power your devices rather than incorporating an additional power supply into your system. First and foremost, it might not be feasible to supply additional power to your system if your application is in a remote area, for example. In this case, your transmitter might be powered by a battery, solar cell, or some other power source and the other devices in the system would derive their power from the transmitter. The expense of running additional lines may also make additional power other than just the 4-20 mA signal cost prohibitive.

Because there is only one power source for the entire system (often supplied by the transmitter which is outputting the 4-20 mA signal), loop-powered devices are also incredibly simple to setup.

Only two wires, the positive and negative connections to the current loop, are required. This is in contrast to three and four wire setups, which incorporate an external power supply into the mix. This makes installation complexity minimal. Loop-powered devices are often much lower cost than other process control devices with built-in high power electronics. This is simply because the expensive components that could be included in these devices such as power supplies, mechanical relays, or advanced digital or analog signal output components are omitted in order to limit the amount of power necessary to operate the device.

Many loop-powered devices are approved for use in hazardous areas as Non-incendive (N.I.) or Intrinsically Safe (I.S.). Both of these approvals require the device to consume such little power that it cannot cause combustion under



The operating temperature spec is often overlooked. It is critical for devices with LCD indication, since many will have trouble in cold weather, such as -20 or -40°C

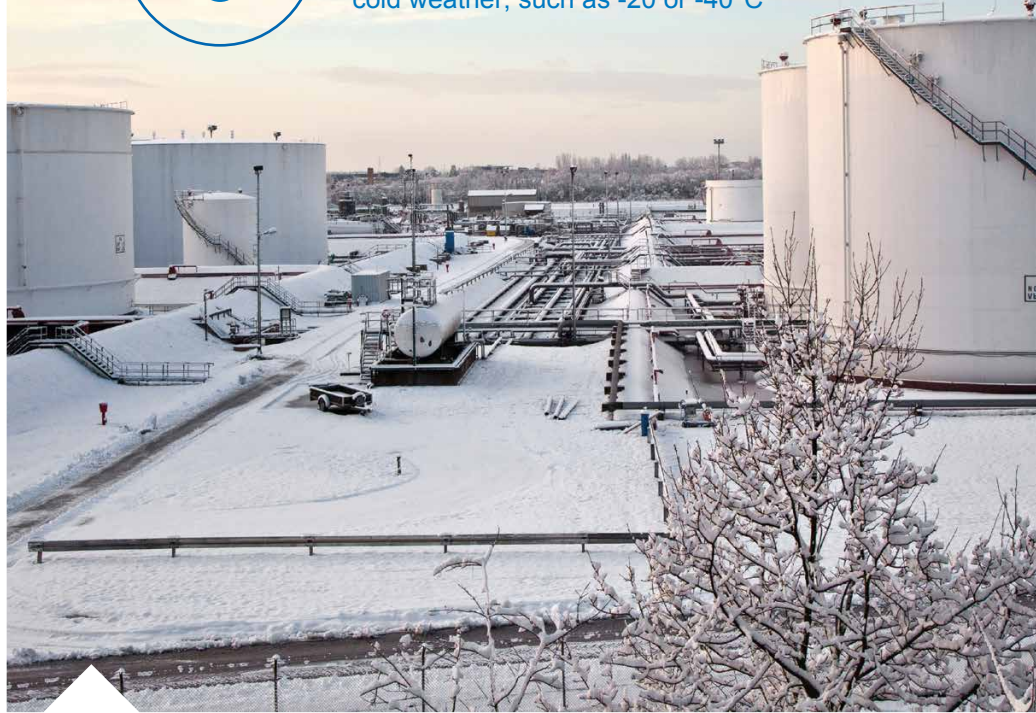

normal operating or fault conditions, respectively. Since the power consumption of loop-powered devices is so low by necessity, they are usually easy candidates for these approvals.

Limitations

The advantages of utilizing loop-powered devices make them solid contenders for many process control applications. There are some drawbacks, however, which must be taken into account before planning to use loop power in your particular application. These drawbacks may be minor or could potentially completely disqualify the use of loop-powered devices.

First and foremost among the disadvantages is the fact that loop-powered devices are operating on the finite amount of power supplied to the 4-20 mA current loop, and add a voltage drop into the loop. The power supply for 4-20 mA

loops is typically 24 V, but can vary. All of the loop-powered devices on the loop need to be powered by this one power supply. Because of this, it is imperative that you check the voltage drop specification on all of your devices in order to ensure that the power supply is capable of supplying enough voltage for all of the components within the loop. The sum of all the voltage drops on all devices in the loop must be less than the voltage of the power supply. It is best to allow some room for error and supply fluctuation, such that the total of all voltage drops is less than 80% of the supply voltage.

The voltage drop specification is supplied in a variety of formats. It could potentially be formatted as a maximum voltage drop for the device (e.g. 3.0 V_{max}), a voltage level at a specific current level (e.g. 3V @ 20 mA), an input impedance (e.g. 150 Ω), or a lookup table showing supply voltage versus equivalent resistance.



Critical Specifications to Remember

If you are considering a loop-powered device for your application, there are several critical specifications you should be aware of before making your final choice:

VOLTAGE DROP

Check the voltage drop specification to ensure the power supply delivers enough voltage for all of the components within the loop.

OUTPUTS

If outputs are required from your loop-powered device, carefully review the type of outputs and the ratings that are available. Loop-powered devices are required to have low-power outputs, such as passive 4-20 mA outputs rather than self-powered outputs, and open collector transistor outputs rather than relays. Be sure your system is designed to work with the outputs available. Plan in advance for any external power supplies, external relays, or other equipment your system may require to work with these outputs.

OPERATING TEMP

This is a spec that is often overlooked. It is critical for devices with LCD indication, since many will have trouble in cold weather, such as -20 or -40°C

When is it Your Best Choice?

Carefully consider the pros and cons to determine if loop-powered devices are the right solution for your application. Remember, loop-powered devices are often inexpensive and easy to install and maintain. They often also feature important agency approvals such as Intrinsically Safe (I.S.) and Non-incendive (N.I.) approvals which are vital if you plan to use them in hazardous areas. The drawbacks to loop-powered devices include the limited number and type of outputs and very low power, which does not allow the use of LED displays, mechanical relays, and limits serial communications.

Here are a few items to consider that can help you disqualify loop-powered devices for your application:

1. Do you need an LED or a more advanced LCD display?
2. Does your application require mechanical relays?
3. Do you require a self-powered 4-20 mA output from your device?
4. Do you require the use of serial communications?
5. Does your loop power supply provide enough voltage to support loop-powered devices?
6. Does your application utilize a process signal other than a 4-20 mA current loop?

If the answer to any of these questions is 'yes,' then you will immediately know that utilizing loop-powered devices is not appropriate for your application.

Summary

The term loop-powered simply means that the device in question receives its power from the 4-20 mA process signal connected to the device. This is possible because current is the same throughout the 4-20 mA loop, so voltage drops caused by loop-powered devices do not affect the current signal.

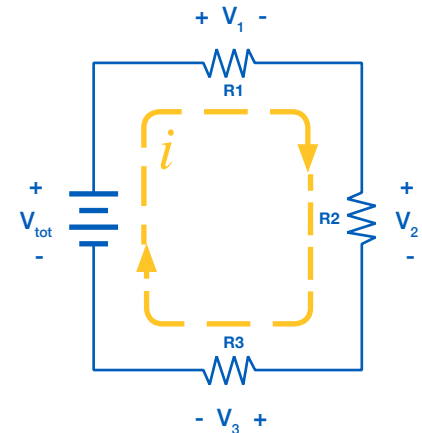

Loop-powered devices are simple, easy to wire and use very little power. However, it is important to be aware of the limitations of loop-powered devices, such as the unavailability of relays, LED displays, or advanced serial communications. You must be sure to pay attention to the specifications, such as voltage drop, output requirements, power requirements, operating temperature and hazardous area approvals, in order to avoid problems with your particular control system. If your application requires an inexpensive, easy-to-install, low power solution and none of the aforementioned disqualifying factors apply, then loop power may be the right answer for your application.

by Simon Paonessa - Technical Writer
Precision Digital Corporation

WHEN EVERY INCH COUNTS

Feet & Inches Meters Provide Clear and Intuitive Level Readings



Many tanks are manually gauged in feet and inches and that is often the way operators are used to seeing the data. Unfortunately, many digital meters can only display in decimal format. Precision Digital's new Feet & Inches meters solve that dilemma by providing the tank level in the way that operators are used to dealing with it: in Feet and Inches!

Benefits

- 

Clear level readings in feet, inches, and 8th or 16th of an inch
- 

Intuitive level indication with tank height bargraph
- 

Work with any 4-20 mA or multivariable transmitters
- 

Program without removing cover with SafeTouch[®] buttons

Benefits and features vary by model and/or options available.









 Explosion-proof. Complete product approved

See Feet & Inches Displays
www.predig.com/feetand_inches



Advanced Data Collection at Oil Fields

by Alan Williams
VP of Sales
Precision Digital Corporation



Photo courtesy of Turbines, Inc.
PD6830 Mounted on Turbines, Inc.
Flow Meter

➔ During the start of the recent oil boom the number of drilling rigs were growing aggressively, as was the cost to maintain them all. Rather than rely on manual data collection in the field, which is time consuming and potentially dangerous, a major oil services company decided to deploy flow rate totalizers with the ability to automate the data collection in their oil fields.

There were a number of factors that were critical in deciding on a flow rate totalizer solution. These factors included the need for easy and fast installation, ability to integrate with their

preferred Turbines Inc. flow meter, reliability and robustness in a harsh field installation, easy Modbus® connectivity, and accurate data collection with a real time clock.

After extensive evaluations between Precision Digital's PD6830 and the incumbent Cameron NUFLO™ MC-III™, the PD6830 was selected. Key in the selection was the PD6830's advanced data collection capabilities which includes a real time clock that ensures the fidelity of important flow data.

However, one critical issue remained. Like many companies, the customer had an installed base of legacy flow rate totalizers already integrated with its data collection systems - what was really needed was a solution that would be a plug-and-play replacement and could be installed without the need to reprogram the data collection system.

Precision Digital engineers got to work and, in a matter of weeks, were able to modify the Modbus® interface of the PD6830 to mimic the registers of the incumbent flow meter. By partnering

with Turbines Inc., Precision Digital facilitated the provision of an ideal customized solution to the customer's data collection dilemma. As a result, the customer installed new flow rate totalizers, as well as upgraded their legacy systems - all while maintaining compatibility, improved fidelity and accuracy of the data, and minimal engineering changes to their data collection system.

The bottom line was reduced maintenance cost, reduced installation costs, and a solution that provided the lowest total cost of ownership. These savings become even more significant as the customer looks to upgrade several thousand systems per year.



Robust Performance

The ProtEX Series continues to deliver a robust and efficient solution to hazardous areas around the world. With a full range of standard features and functionality, the ProtEX Series performs brilliantly in demanding and diverse applications.

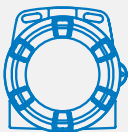

**RUGGED
NEMA 4X / IP68
ENCLOSURE**



**FULLY
APPROVED
EXPLOSION-PROOF**



**SUNLIGHT
READABLE
DISPLAYS**



**4-20 mA
AND ALARM
OUTPUTS**

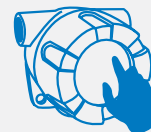

**SAFETOUGH®
THRU-WINDOW
PROGRAMMING**

See What ProtEX Has to Offer
www.predig.com/protex





HAZARDOUS AREA CLASSIFICATIONS:

What You Need To Know.



During the evening of February 7th, 2008, a series of explosions at the Imperial Sugar manufacturing facility in Port Wentworth, Georgia, just outside of Savannah, resulted in the deaths of fourteen workers and numerous injuries. According to Georgia Fire Commissioner John Oxendine, "It was a very large explosion that totally destroyed the three-story building where it took place."¹ The explosion is believed to have been fueled by the ever-present sugar dust, an inherent aspect of the sugar refining process, which would coat surfaces and equipment in the facility.

A resulting investigation performed by the U.S. Chemical Safety Board looking into the explosion concluded that the incident was "entirely preventable" and was the result of "inadequate equipment design, poor maintenance and ineffective housekeeping."² The sugar conveyor located between two of the sugar silos on which the explosion most likely occurred was "found [to have] sugar dust four feet thick in some areas."³ In industrial settings such as this, utilizing equipment that is designed

specifically for explosion prone areas can substantially reduce the risk of combustion.

Areas that have the potential for an explosion to occur are classified as *hazardous areas* and are regulated by multiple organizations and standards worldwide. These organizations are in place in order to ensure that areas that have the potential for an explosion to occur are maximizing the safety of personnel and limiting the possibility of property damage.



While a sugar refinery might be the last place that one would consider to be a hazardous area, the fine dust created by the refining process is in fact very combustible under the right conditions. Other industrial facilities that are commonly considered hazardous areas are paint shops, corn and flour mills, chemical plants, tanks, oil and natural gas wells and liquid transfer terminals. It may not be immediately obvious, but the potential for explosion can exist many hundreds or even thousands of miles away from the source of the explosive material, while it is in any link of the custody transfer process.

Hazardous Area Classification

An industrial area is considered a hazardous area when it contains three fundamental components: A flammable substance (which can be a gas, liquid, or solid), an oxidizer, and a source of ignition. The flammable substance can be anything from gasses and liquids such as hydrogen, gasoline and kerosene, to solid particulate such as dust or small fibers. The oxidizer is usually just the oxygen present in the open air. The source of ignition can be something obvious like a spark or open flame, or something seemingly more innocuous like excessive heat which can cause spontaneous combustion of certain materials.

Hazardous area standards require the use of equipment specifically certified for use in areas that have all three of the above ingredients for an explosion. Though the goal of all hazardous area equipment is to prevent an explosion, the methods that they use vary depending on their manufacture and intended

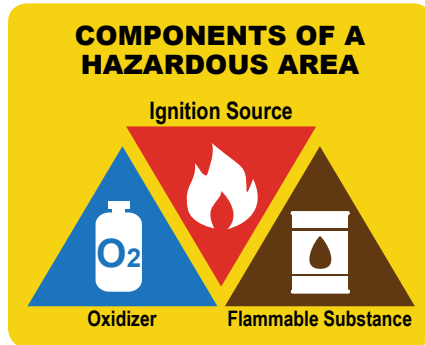

application. There are three primary ways to prevent an electronic device from causing an explosion. The first is to contain the explosion with an explosion proof device or enclosure. This approach is for equipment which, by its very nature, is going to generate enough electrical current and/or heat to cause an explosion if in contact with an explosive substance. In the case of an explosion, however, the device itself or the enclosure that encapsulates the device will contain the explosion and prevent it from spreading.

The second approach to simply remove the possibility of a spark or other source of ignition. This can be accomplished by keeping the temperature low, keeping all electronics secure or using a device

that does not generate enough heat or electrical current to create combustion when in the presence of a flammable substance. The third approach is to simply isolate the explosive substance from anything that could possibly ignite that material. This, however, is not always possible.

As may already be apparent, ensuring safety in a hazardous area is not a very straight forward matter. There are many different industries in which certain areas of their operations may be considered hazardous and several different means by which to prevent an explosion from occurring. It may not even be apparent to those in these industries that the potential for an explosion even exists. This is why there are many regulations, guidelines and laws guiding these industries toward implementing the best practices available. The agencies maintaining and enforcing these are the country's National Electrical Code (or equivalent organization), National Fire Protection Association, OSHA (in the United States), and the requirements of the facilities' specific insurance company.

Agencies That Certify Equipment Used In Hazardous Areas



APPROVED



LISTED

FM (Factory Mutual) and UL (Underwriters Laboratories) provide standards, testing and certification in the United States. CSA (Canadian Standard Association) does the same for Canada. UL, FM, and CSA all have implemented programs allowing certifications to be valid in both countries.



ATEX (Appareils destinés à être utilisés en ATmosphères EXplosives) and IEC (International Electrotechnical Commission) provide standards that are recognized on a more international level. Unlike FM, UL and CSA, they do not perform their own testing but rather have notified bodies perform the testing to meet the standards they set.

These organizations will require, among other things, the use of hazardous area equipment in areas which possess the three components necessary for an explosion. What equipment is qualified for use in a hazardous area is regulated by many certifying agencies. In North America, traditionally, FM (Factory Mutual) and UL (Underwriters Laboratories) provide standards, testing and certification in the United States while CSA (the Canadian Standard Association) does the same for Canada. More recently, UL, FM, and CSA have all implemented programs allowing certifications to be valid in both countries.

Outside of North America, ATEX (Appareils destinés à être utilisés en ATmosphères EXplosives) and IEC (International Electrotechnical Commission) provide standards that are recognized internationally. These organizations, unlike FM, UL and CSA, do not perform their own testing but rather have notified bodies perform the testing to meet the standards they set. Many North American companies will certify their products to ATEX

and/or IEC standards in order to make them applicable to international businesses. Though there are differences between the certifications that these organizations offer, the major reasons for choosing a product certified through one organization over another are the location of the facility and the requirements of the local regulations.

These organizations have a (relatively) uniform approach when it comes to actually classifying equipment for use in hazardous areas. Through rigorous testing, a piece of equipment is assigned an area classification, division or zone, equipment group, and temperature class. An example of a Class I area would be an oil refinery, paint shop, or offshore oil rig. A Class II might be a coal mine, grain silo or hay storage facility. Class III would be something like a paper mill, textile mill, or woodworking facility.

Furthermore, a division or zone is assigned to the product. This is a description of the frequency with which the combustible gas and/or dust is present within the hazardous area. Divisions were used in older North American hazardous area

standards, while zones are used in European/International standards as well as newer North American Standards.

The newer standards have switched to the use of zones, in part because they break down areas that previously were only described by two divisions into three more precise zones. Zones also have the added benefit of including the area classification with the zone description. Zone 0 describes an area in which a combustible gas will be present continuously while zone 20 describes an area in which combustible dust will be present continuously (the '2' in 'zone 20' indicates dust as opposed to gas).

The equipment group describes the type of hazardous material that is or could be present in the hazardous area. North American and international organizations use different standards to represent the equipment group, but they all describe the same thing: the type of combustible material in the presence of which the equipment can be operated.

Lastly, a device meant for use in a hazardous area is assigned a



Classifications for Hazardous Areas

Classes



Class I – Suitable for use in an area where flammable vapors or gasses may be present.



Class II – Suitable for use in an area where combustible dust may be present.



Class III – Suitable for use in an area where ignitable fibers or flying debris may be present.

Divisions



Division 1 - Area in which a hazardous or ignitable substance is present or expected to be present for long periods of time (or all the time) under normal operating conditions.



Division 2 - Area in which hazardous or ignitable substances are only ever present under abnormal conditions (e.g. in the case of a leak).

Zones



Zone 0 / Zone 20 – Area in which a hazardous or ignitable substance is present or expected to be present *continuously* for long periods of time (or all the time) under normal operating conditions.



Zone 1 / Zone 21 – Area in which a hazardous or ignitable substance is present or expected to be present *intermittently* for long periods of time (or all the time) under normal operating conditions.



Zone 2 / Zone 22 - Area in which hazardous or ignitable substances are only ever present under abnormal conditions.

temperature class. The temperature class is the maximum ambient surface temperature the device can reach (under maximum dust layers where applicable). This rating is given to help prevent combustion based on the combustion point of the material present in the area. This is used to determine the ambient operating temperature of the device. The approved product will also have a maximum ambient operating temperature. Most facilities will want to operate at a maximum of 80% or below of the maximum ambient operating temperature. Some examples of temperature ratings commonly seen on devices are T1 (450°C), T3 (200°C), T4 (135°C), and T6 (85°C). Traditional US and Canadian systems may also include such temperature classes as T2A, T2B, T3C, etc., which indicate more precise temperature ratings.

As mentioned previously, there are several methods by which devices can prevent explosions in hazardous areas. First, an explosion-proof, flame-proof, or powder-filled device is one in which the explosion is contained and extinguished. Second, limiting the energy of the device to a point where combustion becomes impossible even in the presence of a flammable material, effectively removing the ignition source, is known as intrinsically safe or non-incendive. A non-incendive device prevents ignition under normal conditions. An intrinsically safe device prevents ignition in double-fault conditions. Lastly, a device can simply keep the flammable materials out of the electrical or heat producing components through pressurization, encapsulation, oil emersion, fiber and flying protection, or protection by enclosure. The particular protection concept that a device uses is represented by a marking on the device such as AEXd (Flameproof

C1 Z1), Ex ia (I.S. CI Z0). These markings can be looked up on tables and charts available online from the various hazardous area approval agencies.

Reading Hazardous Area Approval Labels

A device that has been certified by one of the aforementioned agencies will bear that agency's mark so that the device purchaser and installer can know immediately that the particular device is approved for use in a hazardous area. All of the information about area classification, division and/or zone, equipment group and temperature class is also provided on the equipment label. It may not be readily apparent how to make

sense of it all, however. On the next page is an image of the product label from a Precision Digital product, the PD8 ProtEX-MAX, with all applicable agency approval information.

What may look like a jumble of letters and numbers is actually very specific and crucial information that is necessary for any hazardous area application. An installer or purchaser needs to be able to break down this code in order to properly vet the equipment being installed.

Understanding the regulations and standards by which industrial equipment should be approved in order to operate in a hazardous area is fundamental to ensuring the safety of personnel and property. As evidenced by the unfortunate events

Examples of Protection Concepts



Explosion-Proof

A device capable of containing an explosion and extinguishing the flame internally, preventing ignition external to the device.



Intrinsic Safety or Non-incendive

A device that removes the ignition source by limiting power to levels insufficient to cause arcs, sparks, or hot surfaces.



Pressurized

A device whose internal circuitry is under pressure which ejects any combustible gas and dust.

Product Label for a PD8 ProtEX-MAX Explosion-Proof Meter

The product label pictured below shows all applicable agency approval information for hazardous areas:

- | | | |
|---|----------------------------------|--|
| 1 IECEx Approved (logo optional) | 8 IP per ATEX & IEC | 16 AEx = Explosion Protection, C1, Z1 & 2 CAN
Ex = Explosion Protection, C1, Z1 & 2
tb = Protection by Enclosure
IIC = Gas type IIC (Acetylene, Hydrogen, Carbon Disulfide)
IIIC = Dust type IIIC (Conductive) |
| 2 Environment G: Gas D: Dust | 9 FM/CSA Class/Division | |
| 3 Equipment Category (high level of protection, 1 fault protection) | 10 NEMA & IP per FM & CSA | |
| 4 Equipment Group II (all areas but mines) | 11 FM / CSA Groups | |
| 5 Agency Required Warnings | 12 FM Certified | |
| 6 CE Compliant | 13 CSA Certified | |
| 7 ATEX Certified | 14 Temperature Codes | |
| | 15 Allowable Ambient Temperature | |
| | | 17 Certification Numbers |
| | | 18 FM/CSA Class/Zones |

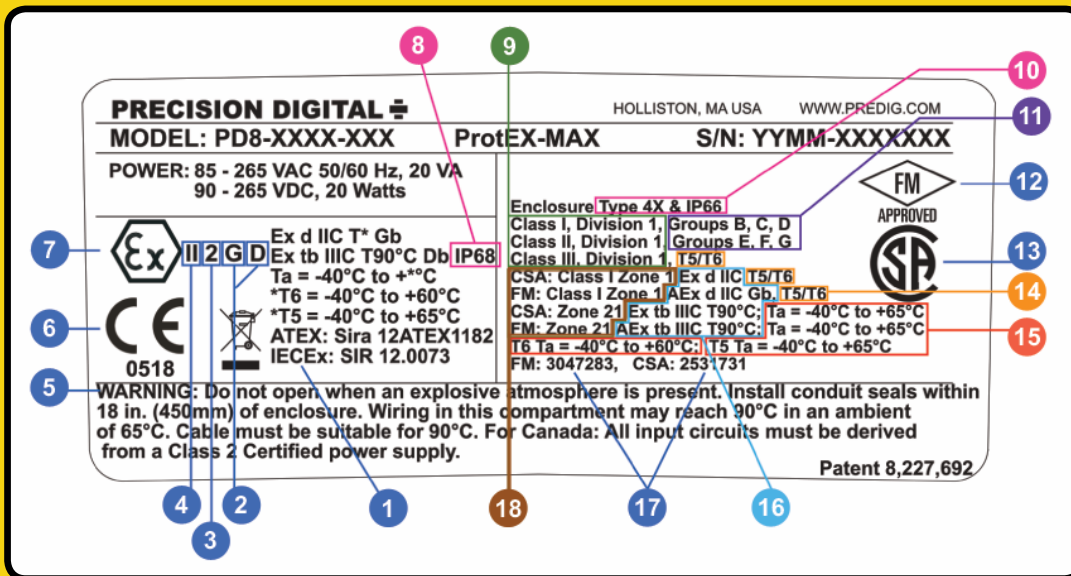

which took place at the sugar refinery at Port Wentworth and by many other industrial accidents that have occurred before and since, great precautions must be taken when working with potentially flammable materials. The hazardous area regulations pertaining to electrical devices operating in potentially flammable environments are only one small part of the regulatory requirements necessary in order to prevent disastrous situations. However, being able to understand

the specifications and classifications of hazardous area devices is imperative to purchasing and installing the correct equipment for your location.

If you or someone you know is unsure or unaware if their work environment is potentially hazardous or for more information on hazardous area specifications, contact your local agency representative.

For more information on hazardous areas visit the following websites:

FM - www.fmglobal.com

IECEx - www.iecex.com

ATEX - www.siracertification.com

CSA - www.csagroup.org

by Simon Paonessa - Technical Writer,
Precision Digital Corporation

¹ Bigg, Matthew, Four dead in sugar refinery blast, Reuters, 8 Feb. 2008
 <<http://www.reuters.com/article/2008/02/08/us-usa-explosion-sugar-idUSN0743207120080208>>

² Dewan, Shaila, Report Cites Lack of Precautions in 2008 Sugar Plant Fire, The New York Times, 24 Sept. 2009,
 <<http://www.nytimes.com/2009/09/25/us/25sugar.html>>

³ Ibid.



NEW
**2015
CATALOG & PRICE LIST**



Request yours at catalog.predig.com